

240 VOLT 1Ø 80 AMPS

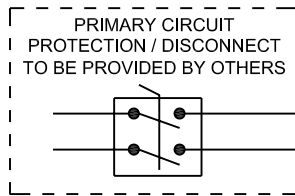

ZONE 1  
8 KW MAX

ZONE 2  
8 KW MAX

□ L1  
□ L2

LOW VOLTAGE CONTROL INPUT

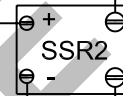
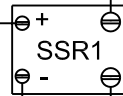
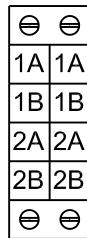

40 AMP

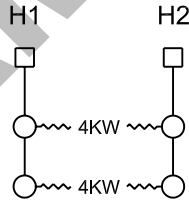

40 AMP

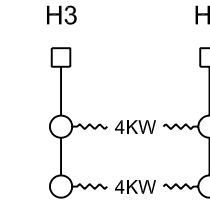

**INFRA TECH**  
344 W. 157th Street  
Gardena, California 90248  
Phone: (310) 354-1250  
Fax: (310) 523-3674  
WWW.INFRATECH-USA.COM

DESCRIPTION  
2 RELAY MAIN CONTROL PANEL  
240 VOLT SINGLE PHASE 80 AMP

CUSTOMER  
SAMPLE

DATE Aug. 28, 2008	ITEM# X-30-4052
JOB# N/A	UL# SAMPLE

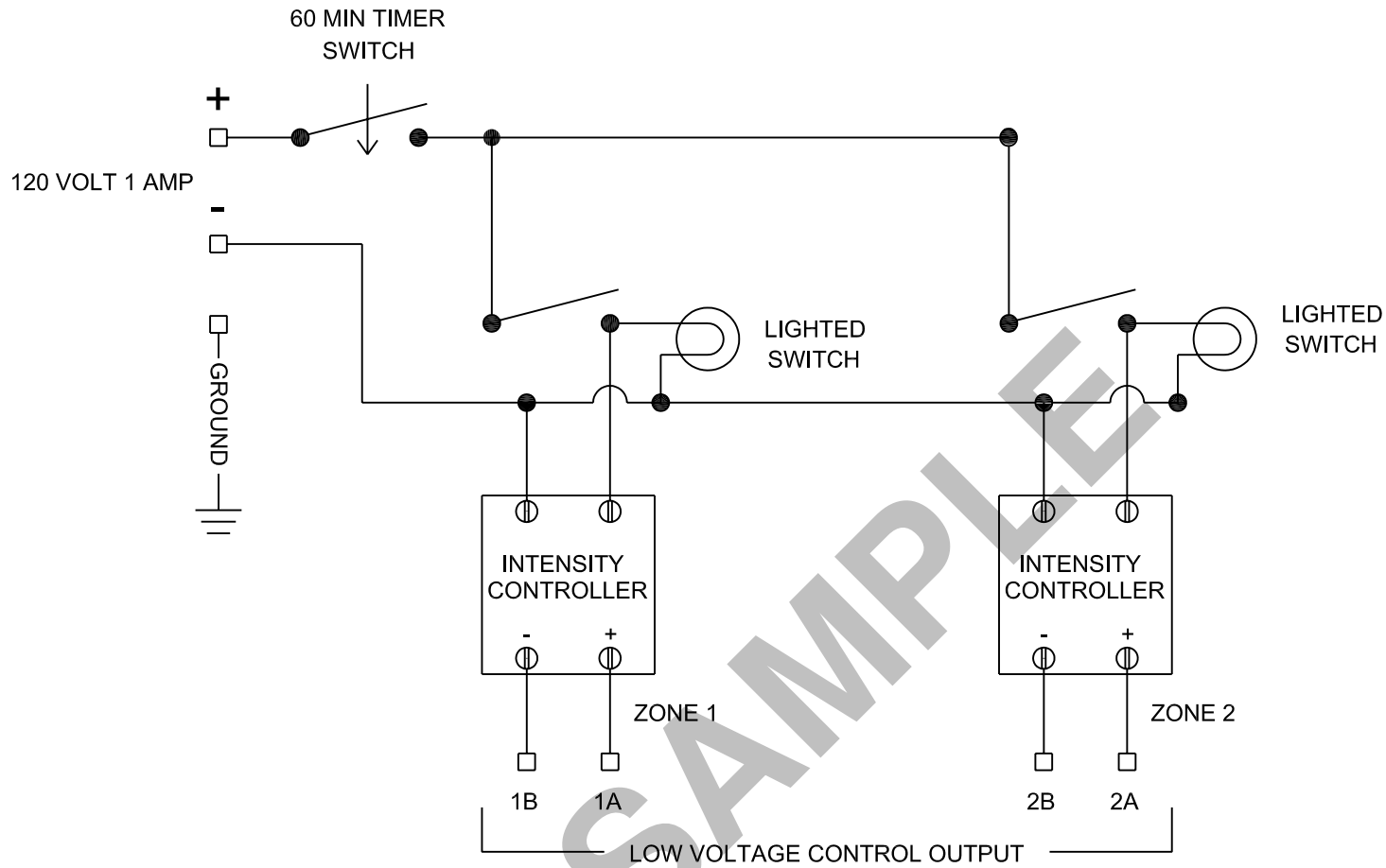

NOTE: USE TWISTED PAIR OR SHIELDED WIRE FOR LOW VOLTAGE HOOK-UP.

**INFRA TECH**  
 WWW.INFRATECH-USA.COM

344 W. 157th Street  
 Gardena, California 90248  
 Phone: (310) 354-1250  
 Fax: (310) 523-3674

DESCRIPTION  
 2 ZONE ANALOG REMOTE CONTROL UNIT

CUSTOMER  
 SAMPLE

DATE Aug. 28, 2008	ITEM# X-30-4033
	JOB# N/A